

# Photographing Historic Structures: Guidelines and Photo Logs



Illinois Department of Transportation

Prepared by the Illinois Department of Transportation  
Bureau of Design and Development  
Cultural Resources Unit

2300 S. Dirksen Parkway  
Springfield, IL 62764

# **Photographing Historic Structures: Guidelines and Photo Logs**





## Table of Contents

Federal and State Regulations Concerning Historic Structures .....	4
Section 106 .....	5
Section 4(f) .....	6
20 ILCS 3420 .....	7
Photo Log Questions and Answers .....	8
Photo Log Requirements .....	10
Photo Log Example .....	11
Clear Photographs .....	14
What Not to Photograph .....	16
Categorization of Historic Structures .....	18
Historic Architectural Styles .....	19
Historic Barns and Bridges .....	44
Glossary of Architectural Terms .....	46
Bibliography and Suggested Sources .....	51

## **Federal and State Regulations Concerning Historic Structures**

Several State and Federal regulations concern the treatment of historic properties. These were put in place to assure that historically significant districts, sites, buildings, structures, and objects were preserved. Though iconic buildings and structures, such as the Old State Capitol or the Sugar Creek Covered Bridge, are preserved under the legislation, they are not the only properties that are protected. Any structure that was built at least fifty years ago is considered historic. While all structures over fifty years old cannot, and should not, be preserved, the legislation requires that they be identified and evaluated for significance.

The primary preservation legislation that needs to be followed is:

- Section 106 of the National Historic Preservation Act (1966)
- Section 4(f), established under the Department of Transportation Act of 1966
- State 707, the Illinois State Agency Historic Resources Preservation Act (1989)

State and Federal funding and permitting requires adherence to the legislation. The requirements set forth by the aforementioned legislative acts need to be fulfilled to receive financial assistance for transportation projects.

## Section 106

Section 106 in the National Historic Preservation Act (NHPA) of 1966 requires review of all federally funded or permitted projects for their impact on historic properties.

Section 106 of the NHPA requires Federal agencies to take into account the effects of their undertakings on historic properties and afford the Advisory Council on Historic Preservation a reasonable opportunity to comment on such undertakings.

“The section 106 process seeks to accommodate historic preservation concerns with the needs of Federal undertakings through consultation among the agency official and other parties with an interest in the effects of the undertaking on historic properties, commencing at the early stages of project planning. The goal of consultation is to identify historic properties potentially affected by the undertaking, assess its effects and seek ways to avoid, minimize or mitigate any adverse effects on historic properties.”

## Section 4(f)

The Section 4(f) legislation under the Department of Transportation Act of 1966 (49 USC 303, 23 USCS 138) provides protection for publicly owned parks, recreation areas, historic sites, and wildlife and waterfowl refuges from conversion to transportation use. The Federal Highway Administration (FHWA) may not approve the use of land from a publicly owned park, recreation area, wildlife and waterfowl refuge, or any significant historic site unless a determination is made that:

- There is no feasible and prudent alternative to the use of land from the property; and
- The action includes all possible planning to minimize harm to the property resulting from such use (23 CFR 774).

The purpose of a Section 4(f) evaluation is to provide the information required by the Secretary of Transportation to make the decision regarding the use of properties protected by Section 4(f). The evaluation should describe all identified Section 4(f) properties which are proposed to be “used” under the preferred alternative, potential impacts on those properties, and possible mitigation measures to minimize impacts. A “use” occurs (1) when land from a Section 4(f) site is acquired for a transportation project, (2) when there is an occupancy of land that is adverse in terms of the statute’s preservationist purposes, or (3) when the proximity impacts of the transportation project on the Section 4(f) sites, without acquisition of land, are so great that the purposes for which the Section 4(f) site exists are substantially impaired (normally referred to as constructive use).



## **20 ILCS 3420**

The Illinois State Agency Historic Resources Preservation Act, passed in the 1989 legislative session, institutes procedures to ensure that projects consider the preservation and enhancement of historic resources.

This act applies to projects and activities undertaken by the State, funded directly or indirectly by the State, or requiring licenses, permits, or other approvals by the State. It includes local projects that require a permit or approval from a State agency. Federally funded projects are reviewed pursuant to Section 106 of the National Historic Preservation Act of 1966.

If an undertaking could result in changes in the character or use of any historic property, notification must be given to the Director of Historic Preservation at the Illinois Historic Preservation Agency (IHPA). If the Director finds that an undertaking will adversely affect a historic resource, alternatives that could eliminate, minimize, or mitigate adverse effects must be considered.

## Photo Log Questions and Answers

### What are photo logs?

Photo logs, and the associated maps that they are keyed to, provide a visual recordation of all historic properties within a proposed project area.

### Why are they necessary?

Photo logs are necessary to provide the FHWA and agencies, such as the IHPA and the Illinois Department of Transportation (IDOT), with the required information concerning historic properties and structures within a proposed project site. Photo logs allow these agencies to review proposed projects quickly and identify potential problems.

### When are they necessary?

Photo logs are necessary anytime a proposed project may affect a historic building, structure, or district.

### When should a photo log be compiled?

A photo log should be compiled as early as it is feasibly possible during the planning of a project that may affect any historic sites. This enables the regulatory bodies to expedite the required analysis efficiently.

## Who should compile a photo log? Do they need special training?

Photo logs are often compiled by IDOT District staff or project consultants. Photo logs may also be compiled by local governments, state agencies, or regulatory bodies.

Though knowledge of historic architecture is advantageous when compiling a photo log, it is not necessary. No specialized training is required.

## Why standardize Photo Logs?

The standardization of photo logs will help to ensure that all of the required information is present. This allows professional staff to quickly review the information and provide for prompt coordination with appropriate agencies.

## How will the Photo Log be Used?

Photo logs are used as a “first pass” to identify potentially significant historic structures. If any potentially significant historic structures are present and are likely to be affected by a transportation project additional study will be required. This additional study most often takes the form of a Section 106/4(f) report.

## Photo Log Requirements

Photo logs should be clear and straight forward. Each structure should be assigned a number, with all photos of that structure utilizing that number. The assigned numbers should be indicated on a map or an aerial photo of the project area.

Photo logs need to include:

- ◆ The name of the project
- ◆ The county or counties
- ◆ For smaller projects, the municipality where the study is being conducted
- ◆ Name of the photographer or compiler and their affiliation
- ◆ Caption for each photo including the assigned structure number, address, the direction the camera is facing, and the date it was taken

Depending on the size of the project more than one map may be needed to clearly depict the required information. An additional map may also be needed to illustrate where the project is within a city or region.

Maps should clearly show the study limits and existing right-of-way preferably in color with distinctive line patterns. Street names need to be included as well as a north arrow and the scale of each map.

Clearly printed high resolution color photos are needed with a maximum of four photos per 8 1/2" by 11" sheet of paper.

# Photo Log Example



Map of the project area including required information



Figure 1: 1529 S. Noble Ave., camera facing west (12-14-2009)



Figure 2: 1531 S. Noble Ave., camera facing west (12-14-2009)



Figure 3: 1532 S. Noble Ave., camera facing east (12-14-2009)



Figure 4: 1528 S. Noble Ave., camera facing east (12-14-2009)

## Clear Photographs

It is important to take clear photos that show as much of the structure as possible. Some common impediments to clear pictures include trees and plants that hide the structure. When this issue is encountered in warm months, it may be prudent to wait to photograph the structure until late fall or winter when there is less foliage. Sometimes changing the angle from which the photo is taken can also minimize the obscuring foliage.

Photos should be taken from a stationary position. Photographs taken from a moving vehicle are often blurry and important details are unclear.



This house is too obscured by foliage during the summer to allow a clear photograph to be taken. Waiting until winter before taking the photo may alleviate the problem.





The large tree in this photo obscures the house and makes it difficult to see important details.



By simply moving several feet down the road, the house can be photographed from a slightly different angle allowing a clearer view.

## What Not to Photograph

Structures will be encountered that are less than fifty years old, and therefore do not need to be documented. It can be difficult to determine the age of a structure. When in doubt of the age of the structure take a photograph. Having too many photos is better than not having enough to fully document a site.

Certain types of structures tend to be more recent; for example Split-level style houses, mobile homes, and pole barns. In consultation with IHPA, the following types of structures do not need to be documented, unless they possess unique qualities or important historical associations.

- Split-Level houses
- Cape Cod Revival houses
- Contemporary houses
- Mobile Homes/Trailers
- Pole Barns
- Modern Sheds and Garages
- Strip Malls



Split-Level house



Mobile Home/Trailer

## **Categorization of Historic Structures**

A historic structure is categorized as having been built at least fifty years ago. Some of these structures include, but are not limited to:

- Houses
- Commercial Structures
- Barns and Outbuildings
- Bridges

Common historic house styles include, but are not limited to:

- Revivals, such as Greek, Neoclassical, and Gothic
- Victorian styles, such as Italianate, Second Empire, and Queen Anne
- First half of the 20th century styles, such as Tudor, Foursquare, Prairie, Craftsman, and Ranch

As well as basic recordation of the structures within a proposed project area, photo documentation is highly useful in the determination of National Register of Historic Places eligibility. As a tool for determining eligibility, unique historic buildings are of particular interest.

## Historic Architectural Styles

The following are a few examples of the styles and types of historic structures that are often found in Illinois.

Keep in mind that there are many variations of any given architectural style and that the following examples may not exemplify every aspect of every style.

It is highly recommended to anyone who plans on photographing historic structures to consider referencing additional sources. Please see the Bibliography and Suggested Sources at the end of this publication.

Most of the style names, identifying features, and dates in this publication are found in *A Field Guide to American Houses* by Virginia and Lee McAlester. When referencing additional sources, style names and dates are often slightly different.

## Greek Revival

1825-1860

### Identifying Features:

- ◆ Gabled or hipped roof with a low pitch, often with a pediment
- ◆ Cornice line of main roof and porch roofs emphasized with wide band of trim
- ◆ Most have porches (either entry or full-width) supported by prominent square or rounded columns
- ◆ Front door surrounded by narrow sidelights and a rectangular line of transom lights above, door and lights usually incorporated into more elaborate door surround

The top photo is of a vernacular “composite” house with some Greek Revival elements. The primary style characteristics of this house include the wide band of trim with turned cornices in the gable.

## Neoclassical

1895-1950

### Identifying Features:

- ◆ Façade dominated by full-height porch supported by classical columns
- ◆ Façade shows symmetrically balanced windows and center door
- ◆ Classically decorated pilasters

The bottom photo is of a house that exemplifies the Neoclassical style. Note the wide band of trim below the roofline and the accentuated pilasters at the corners. This house also shows a full-height porch supported by classical columns.



### Identifying Features:

- ◆ Steeply pitched roof, usually with steep cross gables (roof usually side-gabled)
- ◆ Gables commonly have decorative vergeboards (often referred to as “gingerbread”)
- ◆ Wall surface extending into gable without break (eave or trim normally lacking beneath gable)
- ◆ Windows commonly extend into gables, frequently having high pointed-arch (Gothic) shape
- ◆ One-story porch (either entry or full-width) usually present, commonly supported by flattened Gothic arches.

The top photo shows an example of a vernacular Gothic Revival house. Note the steeply pitched side-gabled roof with a central cross gable. The center window is tall, narrow, and extends into the cross gable. The porch is a later addition built in the early 20th century.

The bottom photo is of a Gothic Revival church. It is reminiscent of the Gothic churches in Europe, where the style originated. The building has the characteristic pointed Gothic windows, rusticated stone, and the tower has parapets.





### Identifying Features:

- ◆ Two or three stories (rarely one story)
- ◆ Low-pitched roof with widely overhanging eaves having large decorative brackets beneath
- ◆ Tall, narrow windows, which commonly have arched or curved tops
- ◆ Windows frequently have elaborate hoods, often in an inverted U-shape
- ◆ Many have a lantern or tower

The top photo shows a two-story Italianate house. The pitch of the roof is low with widely overhanging eaves supported by large brackets. The windows are tall, narrow, and rounded at the top. Inverted U-shaped hoods decorate the tops of the windows.

The bottom photo is of a Italianate commercial building. The building has a flat roof with an emphasized cornice. Mock brackets made by protruding bricks are under the cornice. The windows are tall and narrow with curved tops. The second story windows have brick hoods over them.

Often many commercial buildings in a historic downtown are Italianate or have some Italianate detailing. The first floor of many of these buildings have been significantly altered due to changing trends in merchandizing. This usually includes the addition of larger display windows and new doors.



## Second Empire

1855-1885

### Identifying Features:

- ◆ Mansard (dual-pitched hipped) roof with dormer windows on steep lower slope
- ◆ Molded cornices often bound the lower roof slope both above and below
- ◆ Decorative brackets usually present beneath eaves
- ◆ Usually two or three stories (never one story)

The Second Empire and Italianate styles were popular during roughly the same time and share many features. The mansard roof is the main defining characteristic of the Second Empire style that differentiates it from the Italianate.

The top photo shows a three-story Second Empire house. The mansard roof has widely overhanging eaves above decorative brackets. The windows have rounded tops covered by decorative hoods. Dormers are present on the steep lower slope of the roof.

The bottom photo is of a Second Empire house where the main focal point of the building is the patterned mansard roof. Heavy molded cornices bind the top and bottom of the lower slope of the roof. Decorative brackets are beneath the overhanging eaves. The windows are tall, narrow, and have curved tops. Subtle hoods created in the brick pattern cover the windows.



### Identifying Features:

- ◆ Steeply pitched roof of irregular shape, usually with a dominant front-facing gable
- ◆ Patterned shingles, cutaway bay windows, towers, and other devices used to avoid a smooth-walled appearance
- ◆ Variety of forms, textures, materials, and colors
- ◆ Asymmetrical façade with partial or full-width porch which is usually one story high and extended along one or both side walls

The top photo shows a Queen Anne house that illustrates many of the features of the style. It has a steeply pitched roof with a front facing gable. Flat wall surfaces are minimized by a number of elements: bay windows, the tower with patterned trim, and decorative shingles in the gables. A one-story porch spreads across the front of the house and wraps around the side wall.

The bottom photo is of a house with Queen Anne detailing. The decorative woodwork in the gables and the porch illustrate the Queen Anne influence on this building. Other influences, such as Italianate (the windows) are also evident.



### Identifying Features:

- ◆ Round arches occurring over windows, porch supports, and/or entrance
- ◆ Masonry walls, usually with rough-cut, squared stonework
- ◆ Many have towers which are often round with conical roofs
- ◆ Façade is usually asymmetrical

There are some Richardsonian Romanesque houses, though the style is more typically found in civic, commercial, industrial and religious buildings.

The top photo shows a church that displays several Richardsonian Romanesque characteristics. The walls are comprised of rough-cut or “rusticated” squared stone. The entrance and the window above the entrance have rounded tops. The façade is asymmetrical with a tower.

The bottom photo is of a Richardsonian Romanesque commercial building. The façade is rusticated stone. The windows are topped with round arches. Unlike many Richardsonian Romanesque structures the façade on the building is symmetrical and has copper accents.

As with the Italianate commercial buildings, often the first floor in Richardsonian Romanesque commercial buildings have been significantly altered.





### Identifying Features:

- ◆ Accentuated front door, usually with a decorative crown (pediment) supported by pilasters, or extended forward and supported by slender columns to form an entry porch
- ◆ Doors commonly have overhead fanlights or sidelights
- ◆ Façade usually shows symmetrically balanced windows and central door
- ◆ Windows with double-hung sashes, usually with multi-pane glazing in one or both sashes
- ◆ Windows frequently in adjacent pairs

The top photo shows a two-story Colonial Revival house. The front door is accentuated by the front porch. Sidelights flank the door. The windows are symmetrically balanced with the first floor windows in adjacent pairs. The glazing in the windows are in a multi-pane configuration in the top sash.

The bottom photo is of a house that is also a two-story Colonial Revival. A pediment supported by pilasters accentuates the front door. The windows are symmetrically placed with multi-pane glazing in both sashes.



### Identifying Features:

- ◆ Steeply pitched roof, usually side-gabled
- ◆ Façade dominated by one or more prominent cross gables, usually steeply pitched
- ◆ Decorative (i.e. not structural) half-timbering present on about half of examples
- ◆ Tall, narrow windows, usually in multiple groups and with multi-pane glazing
- ◆ Massive chimneys, commonly crowned by decorative chimney pots
- ◆ It is also common, but not necessary to the style, to have “sporadic” rustication of materials such as stone interspersed within a brick wall

The top photo shows a Tudor Revival house with a steeply pitched side-gabled roof and a front facing steeply pitched gable entrance. The gable and first floor windows are tall and narrow with the first floor windows in groups. The entrance façade has a combination of brick and rusticated stone. The chimney is crowned with a decorative chimney pot.

The bottom photo is of another Tudor Revival house showing the characteristic side-gabled roof with a prominent cross gable. Note the decorative half-timbering in the peaks of the gables. The windows are tall, narrow, multi-paned, and grouped. The brick façade has rusticated stone strewn throughout it and on the corners where the walls meet.



### Identifying Features:

- ◆ Often two stories
- ◆ Square plan
- ◆ Low to moderately pitched hipped or pyramidal roof
- ◆ Full-width front porch
- ◆ May have a dormer protruding from the front roof slope, may also have dormers on the side and/or rear slopes

The Foursquare is more of a house type as opposed to a style. In addition to the identifying features of the type, elements from contemporary styles are often included. Prairie and Craftsman style features such as deep roof eaves, Craftsman style brackets, and pedestals are common.

The top photo shows a two-story Foursquare house with a pyramidal roof and overhanging eaves. A dormer projects from the center of the roof above the façade. The house has roughly a square floor plan and a full-width front porch. The porch is supported by columns atop pedestals.

The bottom photo is of a Foursquare house with the characteristic two stories and pyramidal roof. Dormers are present on the front and side roof slopes. The house has a square floor plan with a full-width front porch supported by columns atop pedestals.



## Identifying Features:

- ◆ Low-pitched roof, usually hipped, with widely overhanging eaves
- ◆ Two stories, with one-story wings or porches
- ◆ Eaves, cornices, and façade detailing emphasize horizontal lines
- ◆ Often with massive, square porch supports
- ◆ Massive, though short, chimneys
- ◆ Bands of windows (often casement)
- ◆ Usually clad in brick or stucco

The Prairie style was started by Frank Lloyd Wright. Other architects, primarily in Chicago, also designed in this style. The vernacular form spread quickly throughout the Midwest and beyond.

The top photo shows a Prairie style house with low-pitched gable roofs. There are several one-story wings and porches coming off of the main mass of the house. The low pitches of the roof lines and the façade detailing emphasize the horizontal. The enclosed porch is supported by heavy square elements.

The bottom photo is of a Prairie style house with a deeply overhanging low hipped roof. The mass of the house is two stories with one-story wings. The horizontality is emphasized by the façade details, roof lines, and bands of windows.





### Identifying Features:

- ◆ Low-pitched gable roof (occasionally hipped) with wide, unenclosed eave overhang
- ◆ Roof rafters usually exposed
- ◆ Decorative (false) beams or braces commonly added under gables
- ◆ Porches, either full- or partial-width, with roof supported by tapered square columns
- ◆ Columns or pedestals (which are often tapered) frequently extend to ground level (without a break at the level of the porch floor)

Most Craftsman houses in the Midwest are “bungalows.” These are small one- or two-story structures that still embody the style. Chicago has its own interpretation of the bungalow that has become its own subtype.

The top photo shows a Craftsman bungalow with a low-pitched roof and eave overhangs. Decorative beams are located under the gables. The house has a full-width porch supported by tapered square columns that do not break at the porch floor level.

The bottom photo is of a “shed roof” Craftsman bungalow. The house has a side gable with a large front dormer. Simple brackets are located under the overhanging eaves of the gables. A full-width porch is supported by square columns that do not break at the porch level. The shed roof bungalow was very popular and variations of this subtype are common.



### Identifying Features:

- ◆ One story, with a wide, asymmetrical façade
- ◆ Low-pitched hipped or cross-gabled roof
- ◆ Moderate to wide eave overhangs
- ◆ Ribbon or picture windows on the façade, smaller windows in back
- ◆ Decorative shutters or iron porch supports
- ◆ Often have an attached garage

Though some individual Ranch houses are less than fifty years old, the style is old enough to be considered historic.

The top photo shows a Ranch house with a low-pitched gable roof. It has moderate overhanging eaves above bands of windows. The carport and changes in wall depth creates an asymmetrical façade. The house is clad in a brick veneer with stone veneer and siding accents. A garage is attached to the house.

The bottom photo is of a Ranch house with a moderately-pitched hipped roof with wide overhanging eaves. The asymmetrical façade is emphasized by a bay window and changes in the wall depth. Decorative iron elements support the porch roof over the front door.



## Historic Barns and Bridges

Historic barns and bridges are often within a project's survey area. These also need to be photographed.

All round barns and most other types of wood barns are considered historic. Photos of pole barns, corrugated metal structures, fiberglass clad structures, and other modern structures are not required.

Metal truss, wood, and stone bridges are almost always historic. Many types of concrete bridges are also over fifty years old.



Historic barn



Steel Truss, Quadrangular Warren bridge



Timber Stringer bridge

## Glossary of Architectural Terms

**Bracket:** A support element under eaves, balconies, windows, and other overhanging elements; often more decorative than functional

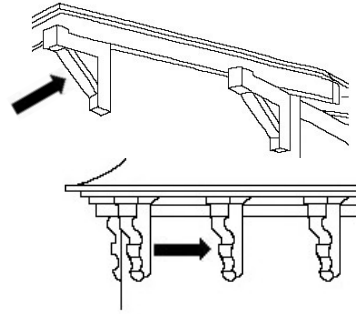

**Chimney Pot:** A pipe placed on top of a chimney that functions as a continuation of the flue and improves the draft

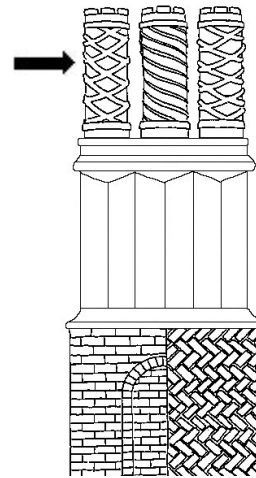

**Cornice:** In classical architecture, projecting ornamental molding along the top of a building or wall

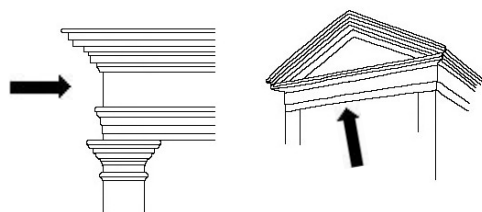

**Dormer:** A vertically set window on a sloping roof

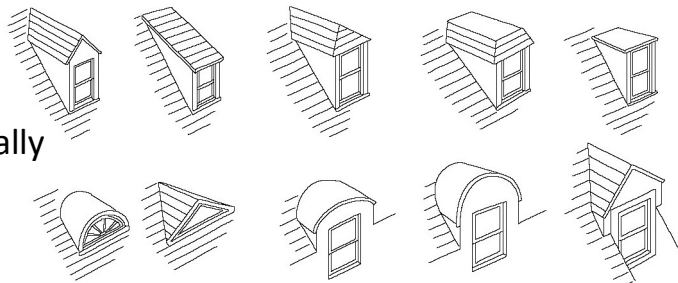



**Double-hung:** A window with two sashes, one above the other, arranged to slide vertically past each other

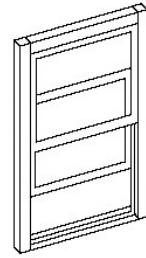

**Eaves:** The projecting overhang at the lower edge of a roof

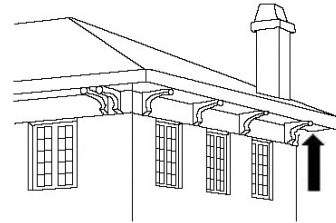

**Fanlight:** A semicircular or fan-shaped window with radiating members set over a door or window

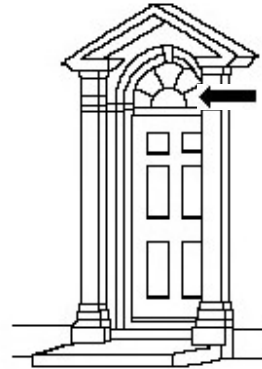

**Gable:** A triangular wall segment at the end of a double-pitched or gabled roof

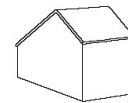
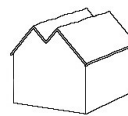
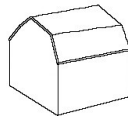
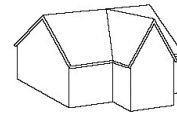
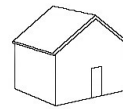
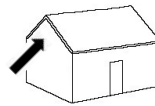

**Glazing:** The glass within a window



**Half-Timbering:** Wall construction in which the timber frame members are visible with the spaces filled with brick, stone, or other material

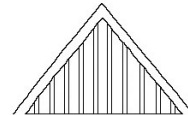
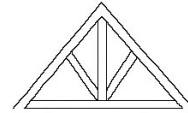
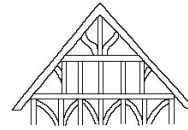

**Hipped Roof:** A roof with four uniformly pitched sides

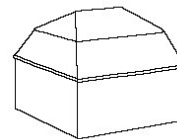
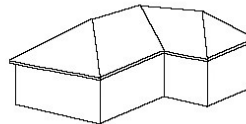
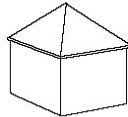
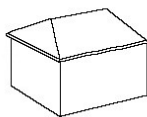

**Hood:** A large molding over a window

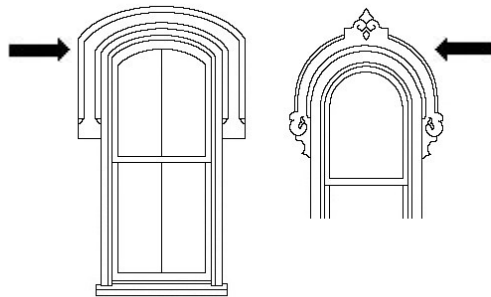

**Lantern:** (Also called a cupola)  
A structure built on the top of a roof with open or windowed walls

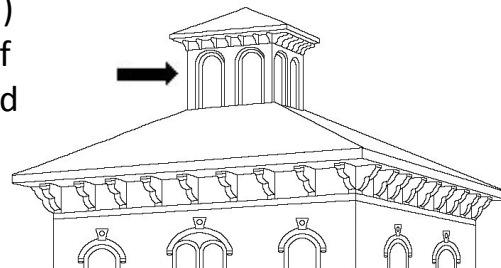

**Mansard Roof:** A roof that has two slopes on all four sides; subtype of the hipped roof

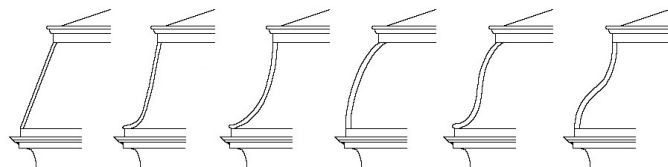

**Molding:** A continuous decorative band that is either carved into or applied to a surface

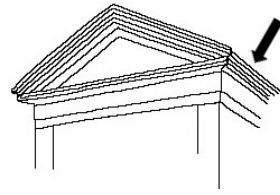

**Parapet:** A low, solid, protective wall or railing along the edge of a roof or balcony

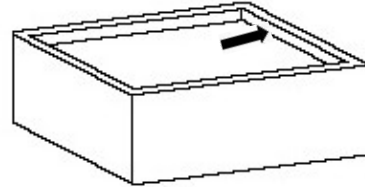

**Pedestal:** An architectural support or base for a column

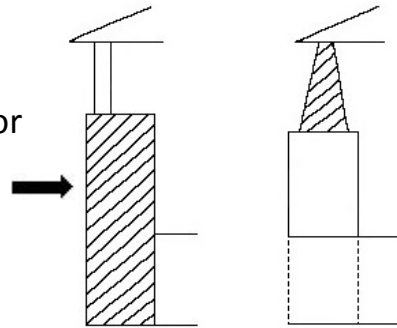

**Pediment:** A wide, low-pitched gable surmounting the façade of a classical style building; any similar triangular crowning element used over doors, windows, and niches

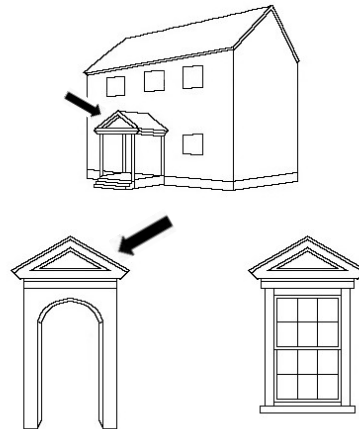

**Pilaster:** A slightly projecting pier or column embedded in a wall; often decorated to resemble a classical column

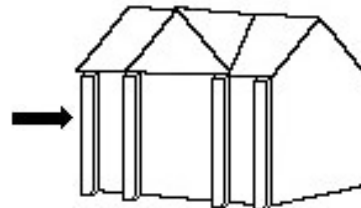

**Rustication:** (Also called rough-cut)  
Masonry cut in massive blocks separated from each other by deep joints



**Sash:** A frame in which the panes of a window are set

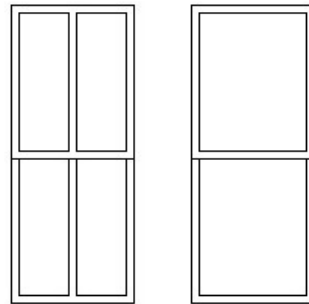

**Sidelights:** Vertical windows on either side of a door

**Transom:** Horizontal window immediately over a door, often accompanied by sidelights

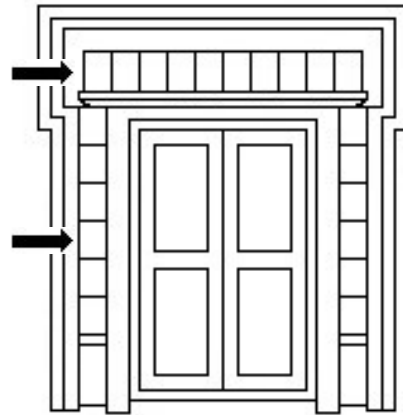

**Vergeboard:** (Also called bargeboard) Ornamental gable trim which is often richly decorated with carved, cutout, or painted designs and patterns

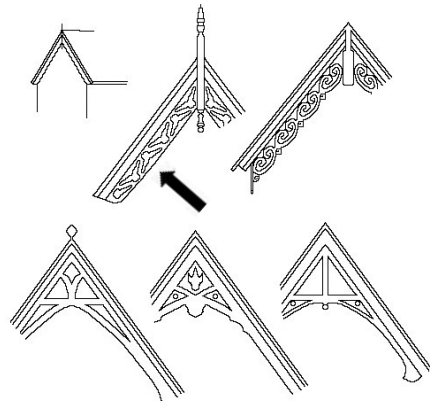

## Bibliography and Suggested Sources

### Laws and Regulations

Illinois Department of Transportation  
<http://www.dot.il.gov/>

Illinois Historic Preservation Agency  
<http://www.illinoishistory.gov/>

National Register of Historic Places  
<http://www.nps.gov/nr/index.htm>

### Architectural Styles and History

Blumenson, John J.-G.. *Identifying American Architecture: A Pictorial Guide to Styles and Terms, 1600-1945*. New York: W.W. Norton & Company, Inc., 1995.

Chambers, Jr., S. Allen, John C. Poppeliers and Nancy B. Schwartz. *What Style is it? A Guide to American Architecture*. Historic American Buildings Survey: The Preservation Press, 1983.

Glassie, Henry. *Vernacular Architecture*. Indiana: Indiana University Press, 2000.

McAlester, Virginia, and Lee McAlester. *A Field Guide to American Houses*. New York: Alfred A. Knopf, 2000.

Whiffen, Marcus. *American Architecture since 1780: A guide to the Styles*. Massachusetts: Massachusetts Institute of Technology, 1999.